

heatmiser®



Model: Slimline V4

Model: Slimline V4





Table of Contents

Product Image	1	Adjusting the Optional Features	23
Table of Contents	2	Optional Features - Table	24
What is a Programmable Room Thermostat?	3-4	Re-calibrating the Thermostat	25
Installation Procedure	5-6	Error Codes	26
Mode Select/Factory Reset	7	Mode 2 - Time Clock	27
Mode 1 - Thermostat	8	LCD Display	28-29
LCD Display	9-10	Setting the Clock	30
Setting the Clock	11	Locking the Time Clock	31
Temperature Display	12	Setting the Switching Times	32
Comfort Levels	13-14	Countdown Mode	33
Locking the Thermostat	15	Timer Override	34
Temperature Control	16	Holiday	35
Temperature Hold	17	Optional Features Explained	36
Holiday	18	Optional Features - Table	36
Frost Protection	19	Adjusting the Optional Features	37
Heating On/Off	20	Wiring Diagrams	39-41
Option Features Explained	21-22		

What is a Programmable Room Thermostat?

A programmable room thermostat is both a programmer and a room thermostat.

The programmer allows you to set “On” and “Off” periods to suit your own lifestyle. The room thermostat works by sensing the air temperature, switching on the heating when the air temperature falls below the thermostat setting, and switching it off once this set temperature has been reached.

So a programmable room thermostat lets you choose what times you want the heating to be on, and what temperature it should reach while it is on. It will allow you to select different temperatures in your home at different times of the day (and days of the week) to meet your particular needs and preferences.

Setting a programmable room thermostat to a higher temperature will not make the room heat up any faster. How quickly the room heats up depends on the design & size of the heating system.

Similarly reducing the temperature setting does not affect how quickly the room cools down. Setting a programmable room thermostat to a lower temperature will result in the room being controlled at a lower temperature, and saves energy.

The way to set and use your programmable room thermostat is to find the lowest temperature settings that you are comfortable with at the different times you have chosen, and then leave it alone to do its job.

The best way to do this is to set the room thermostat to a low temperature – say 18°C, and then turn it up by 1°C each day until you are comfortable with the temperature. You won't have to adjust the thermostat further. Any adjustment above this setting will waste energy and cost you more money.

If your heating system is a boiler with radiators, there will usually be only one programmable room thermostat to control the whole house. But you can have different temperatures in individual rooms by installing thermostatic radiator valves (TRVs) on individual radiators.

If you don't have TRVs, you should choose a temperature that is reasonable for the whole house. If you do have TRVs, you can choose a slightly higher setting to make sure that even the coldest room is comfortable, then prevent any overheating in other rooms by adjusting the TRVs.

You are able to temporarily adjust the heating program by overriding or using the temperature hold feature. These features are explained further on pages 16 and 17 of this manual.

Programmable room thermostats need a free flow of air to sense the temperature, so they must not be covered by curtains or blocked by furniture. Nearby electric fires, televisions, wall or table lamps may also prevent the thermostat from working properly.



Installation Procedure



Do

Mount the thermostat at eye level.

Read the instructions fully so you get the best from our product.



Don't

Do not install near to a direct heat source as this will affect functionality.

Do not push hard on the LCD screen as this may cause irreparable damage.

This Slimline Series thermostat is designed to be flush mounted and requires a back box of 35mm (minimum depth) to be sunk into the wall prior to installation.

Step 1

Carefully separate the front half of the thermostat from the back plate by placing a small flat head terminal driver into the slots on the bottom face of the thermostat.

Step 2

Place the thermostat front somewhere safe.

Terminate the thermostat as shown in the diagrams on pages 39-41 of this booklet.

Step 3

Screw the thermostat back plate securely into the back box.

Step 4

Clip the front of the thermostat back onto the thermostat back plate.

1



2



3

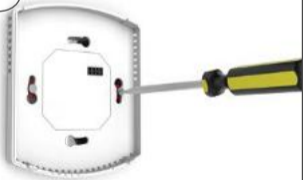

4







Mode Select/Factory Reset

Slimline can either be used as a thermostat or a time clock. Thermostat mode is the default setting.



To change between thermostat & time clock modes, follow these steps.

- Hold down the Power button to turn off the display 
- Press and hold the Power and Up keys together until the LCD powers up. All of the icons will be displayed on screen momentarily 

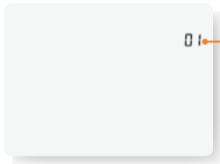
The device will factory reset then provide 2 selectable mode options.



 Mode Indication

- Tap the Up/Down keys to select the desired mode 
 Mode 01 = Programmable Thermostat
 Mode 02 = Time Clock
- Press A to confirm settings..... 
- Tap the Power button to turn the display on 

1 Mode 1 - Thermostat



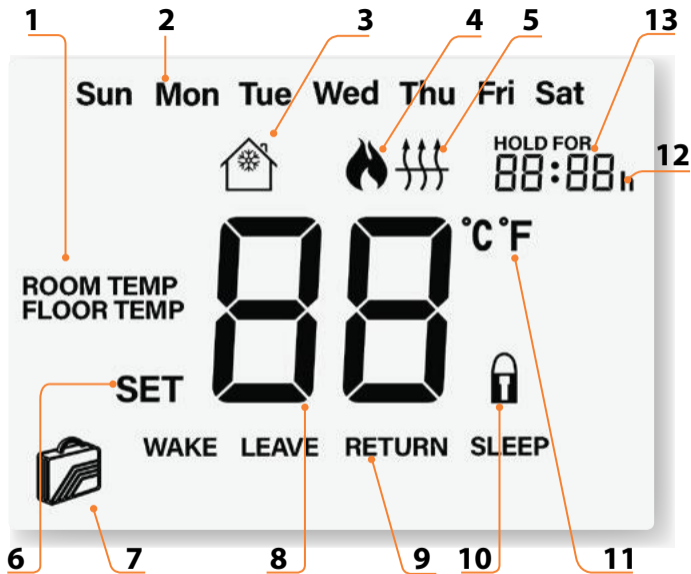







LCD Display

1. Room/Floor Temp - Indicates the current temperature sensor mode.
2. Day Indicator - Displays the current day.
3. Frost Icon - Displayed when the thermostat is in frost protection mode.
4. Flame Icon - Displayed when the thermostat is calling for heat, the flame icon will flash when the optimum start function is in operation.
5. Floor Temp Limit Icon - Displayed when the floor sensor probe has reached the temperature limit set on feature 07.
6. Set - Indicates when changes are being made to programs or temperature set points.
7. Holiday Indicator - Displayed when the thermostat is in holiday mode.
8. Current Temp - Indicates the current sensor temperature.
9. Program Cycle Indicator - Displayed during programming only to show which period is being altered.
10. Keypad Lock Indicator - Displayed when the keypad is locked.
11. Units of Temperature - Degrees Celsius or Fahrenheit.
12. Clock - Digital clock display in 24h format.
13. Temperature Hold - When a Temp Hold is active, HOLD FOR and the remaining time period is displayed.



Setting the Clock (*Programmable Mode*)

To set the clock, follow these steps.

- With the thermostat turned ON, press the Clock key twice 
- Use the Up/Down keys to set the hours 
- Press H to confirm settings 
- Use the Up/Down keys to set the minutes 
- Press H to confirm settings 
- Use the Up/Down keys to set the day of the week 
- Press A to confirm settings and return to main display 

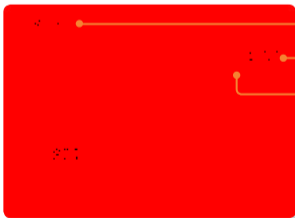

Day

Minutes

Hours

Note: When 'Feature 11' is set to 'Manual Mode' the clock button does not respond.



Temperature Display

This thermostat can be setup to use an air sensor, floor sensor or both.

The display will clearly show which sensor is being controlled by showing either:

Room Temperature

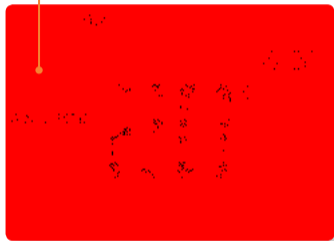

Floor Temperature



When the thermostat is set to use both sensors, the room temperature will be displayed. To view the floor temperature, press and hold the **A** key until the Floor Temp is displayed on screen.



Comfort Levels Explained

(Programmable Mode)

The thermostat offers the following program mode options;

5/2 Day Programming – 4 levels for the weekdays and 4 different levels for the weekend.

7 Day Programming – 4 levels for each day.

24 hour Programming - 4 levels for all days.

Consult the 'Optional Features' section to select the required mode.

- To program comfort levels, press Clock once

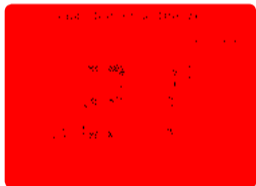



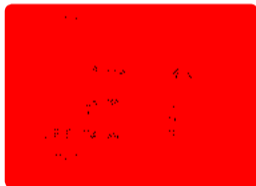



*For Weekday/Weekend programming,
Mon Tue Wed Thu Fri
are displayed on screen.*



*For 7 Day programming,
only Mon is displayed
in the day indicator field.*

For 24 hour programming, all days are displayed.



- Use the Up/Down keys to enter the required WAKE time  
- Press H to confirm settings 
- Use the Up/Down keys to enter the required WAKE temperature  
- Press H to confirm settings 
- You will now see LEAVE displayed on screen.
- Repeat the programming steps for each period until complete.
- For unused periods enter --.-- and the thermostat will ignore the setting.
- Press A to confirm settings and return to main display 

Note: In 7 Day programming mode you can repeat for each day independently. In Weekday/Weekend programming mode you will see Sat Sun displayed on screen and can repeat for the weekend. To change the programming mode please refer to pages 23-24.



Locking the Thermostat

The thermostat has a keypad lock facility. To activate the lock follow these steps.

- Press and hold the A and Down keys together for 10 seconds 
- You will see the lock symbol appear on screen 
- To unlock, repeat the steps above until the lock symbol disappears.

Note: The keypad lock indicator is only displayed when the lock is active.

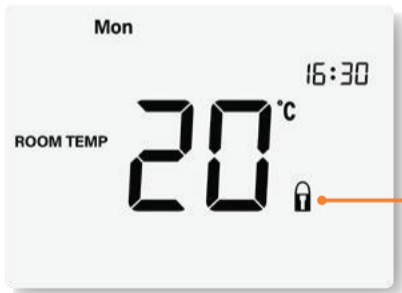

Keypad Lock Indicator



Temperature Control

The Up/Down keys allow you to adjust the set temperature



When you press either key, you will see the word SET and the desired temperature will be displayed on screen.

Use the Up/Down keys to adjust the SET value



Press A to confirm settings and return to main display



Note: In programmable mode, this new temperature is maintained only until the next programmed comfort level.

In non-programmable mode, this temperature will be constantly maintained.

SET 20°C

Set Temperature

Set Icon



Temperature Hold

The temperature hold function allows you to manually override the current operating program and set a different temperature for a desired period.

- Press H to commence temperature hold
- Use the Up/Down keys to enter the required Hold time.....
- Press H to confirm settings
- Use the Up/Down keys to enter the required Hold temperature.....
- Press A to confirm settings and return to main display

You will see the 'Hold For' indication is displayed on screen.

The time will countdown the set duration and then revert to the normal program.



Hold For Indicator

Hold Time Remaining





To cancel temperature hold, follow the same steps but reduce the Hold time to 00:00 hours.



Holiday

The holiday function reduces the set temperature in your home to the frost protection temperature setting (see page 19).

The thermostat will maintain this temperature for the duration of the holiday and will then automatically return to the program mode on your return.

- Press H three times (until you see the suitcase on screen) 
- Use the Up/Down keys to enter the number of days holiday  
- Press A to confirm settings and return to main display 

The display will show a suitcase indicating the thermostat is in holiday mode.

Note: A holiday period does not start until 00:00 the next day. For example, if you set a holiday period on Friday for 2 days, Saturday will be counted as the first day and the thermostat will revert back to the programmed schedule at 00:00 on Monday.

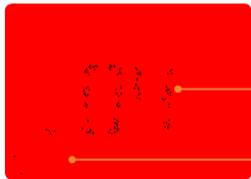



Holiday Days Holiday

ON Indicator

To cancel, follow the same steps but reduce the Holiday duration to 00 days.



Frost Protection

Pressing the Power button  once will place the thermostat in frost protect mode. In this mode, the thermostat will display the frost icon and will only turn the heating on should the room temperature drop below the set frost temperature. Should the heating be turned on whilst in frost mode, the flame icon will be displayed. To cancel the frost protect mode, press the Power button once again. 

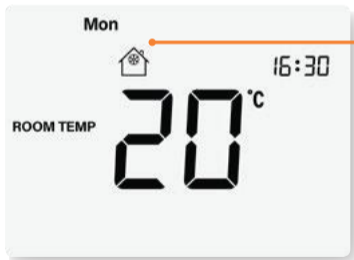

Frost Protection Mode Enabled

Frost set temperature range is from 7 to 17°C (12°C factory default)

Note: If the display is turned off, the frost symbol will appear to represent heat demand in place of the flame symbol.



Heating On/Off

The heating is indicated ON when the flame icon is displayed.

When the flame icon is absent, there is no requirement for heating to achieve the set temperature but the thermostat remains active.

To turn the thermostat OFF completely, press and hold the Power button..... 

The display and heating output will be turned OFF completely.*

To turn the thermostat back ON, press the Power button once again 

Thermostat completely OFF



Thermostat powered ON



*See Feature 3 on page 21



Optional Features Explained

THE FOLLOWING SETTINGS ARE OPTIONAL AND IN MOST CASES NEED NOT BE ADJUSTED

Feature 01 – Temperature Format: This function allows you to select between °C and °F.

Feature 02 – Switching Differential: This function allows you to increase the switching differential of the thermostat. The default is 1°C which means that with a set temperature of 20°C, the thermostat will switch the heating on at 19°C and off at 20°C. With a 2°C differential, the heating will switch on at 18°C and off at 20°C.

Feature 03 – Frost Protect: You can set whether the thermostat will maintain the frost temperature when the thermostat display is turned off. As a default, this is enabled.

Feature 04 – Output Delay: To prevent rapid switching, an output delay can be entered. This can be set from 00 - 15 minutes. The default is 00 which means there is no delay.

Feature 05 – Temperature Up/Down Limit: This function allows you to limit the use of the up and down keys. This limit is also applicable when the thermostat is locked and so allows you to give others limited control over the heating system.

Feature 06 – Sensor Selection: On this thermostat, you can select which sensor should be used. You can select between air temperature only, floor temperature, or both. When you enable both sensors, the floor sensor is used as a floor limiting sensor and is designed to prevent the floor from overheating.

Feature 07 – Floor Temp Limit: When the Floor Sensor has been enabled in feature 06, you can set a floor limiting temperature between 20-45°C, this protects the floor from overheating.

(27°C is the default).

Feature 08 – Optimum Start: Optimum start will delay the start up of the heating system to the latest possible moment to avoid unnecessary heating and ensure the building is warm at the programmed time. The thermostat uses the rate of change information to calculate how long the heating needs to raise the building temperature 1°C (with a rate of change of 20, the thermostat has calculated the heating needs 20 minutes to raise the building temperature 1°C) and starts the heating accordingly.

Feature 09 – Rate Of Change: This is the number of minutes the thermostat has calculated it takes to raise your building temperature 1°C. The thermostat will continue to monitor and learn the heat up time of your home to optimise heating efficiency.

Feature 10 – Programming Mode: The following program modes are available; 5/2 Day Programming – 4 levels for the weekdays and 4 different levels for the weekend.

7 Day Programming – 4 levels for each day.



24 Hours – 4 levels over a 24-hour period.

Feature 11 – Thermostat Mode: Here you can set in which mode you would like the thermostat to operate. The options are, manual (non-programmable) or programmable (Comfort Levels).







Adjusting the Optional Features

To adjust the optional settings, follow these steps.

- Press and hold the Power button to turn the thermostat OFF 
- Press and hold the Clock key until the display appears as shown below 



- Use the Clock key to cycle through the features 
- Use the Up/Down keys to change the setting 
- Press A to confirm settings 
- Press the Power button once again to turn the thermostat back ON 



Optional Features - Table





Thermostat

FEATURE	DESCRIPTION	SETTING
01	Temperature Format	00 = °C, 01 = oF (°C = Default)
02	Switching Differential	01° - 03°C (01°C = Default)
03	Frost Mode	00 = Enabled, 01 = Disabled (00 = Default)
04	Output Delay	00 - 15 Minutes (00 = Default)
05	Up/Down Temperature Limit	00° 10°C (00 = Default)
06	Sensor Selection	00 = Built in Air Sensor 01 = Remote Air Sensor 02 = Floor Sensor Only 03 = Built In & Floor Sensor 04 = Remote Air & Floor Sensor
07	Floor Temperature Limit	20° - 45°C (27°C = Default)
08	Optimum Start	00 - 03 Hours (00 = Default)
09	Rate of Change	Minutes to raise by 1°C
10	Program Mode	00 = 5/2 Day Programming (Default) 01 = 7 Day Programming 02 = 24h Programming
11	Thermostat Mode	00 = Manual, 01 = Programmable (01 = Default)



Re-calibrating the Thermostat

If you need to re-calibrate the thermostat, follow these steps.

- Press and hold the Power button to turn the thermostat OFF 
- Press and hold BOTH the Power and Down keys together until the temperature appears on the screen 
- Use the Up/Down keys to configure the new temperature 
- Press A to confirm settings 
- Press the Power button once to turn the thermostat back ON 

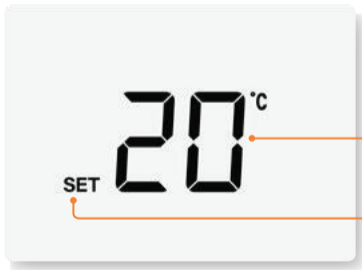

Calibration Temperature Setting

Set Icon



Error Codes

E0 = The internal sensor has developed a fault.
You should contact your thermostat retailer for assistance.

E1 = The remote floor probe has not been connected, has been wired incorrectly or the probe is faulty.

E2 = The remote air probe has not been connected, has been wired incorrectly or the probe is faulty.



Error Number

2

Mode 2 - Time Clock



The time clock can be used to control various devices in and around your home e.g. 'Hot Water', 'Towel Rails' or even 'Lighting'.









Refer to the manufacturers instructions for wiring to these devices.

1. Day Indicator - Displays the current day.
2. Holiday Indicator - Displayed when the time clock is in holiday mode.
3. Set - Indicates when changes are being made to programs or clock settings.
4. Program Cycle Indicators - Displayed during programming only to show which period is being altered.
5. Keypad Lock Indicator - Displayed when the keypad is locked.
6. Timer Status – Displays the current status of the timed output.
7. Clock - Digital clock display in 24h format.
8. Hold For - Displayed when a timer override is active, the remaining time will be shown.



Setting the Clock

To set the clock, follow these steps.

- In Countdown mode, press the Clock button once 
- In either 5/2, 7-day, or 24h mode, press the Clock button twice 
- Use the Up/Down buttons to set the hours..... 
- Press H to confirm settings 
- Use the Up/Down buttons to set the minutes..... 
- Press H to confirm settings 
- Use the Up/Down buttons to set the day of the week 
- Press A to confirm settings and return to the main display 

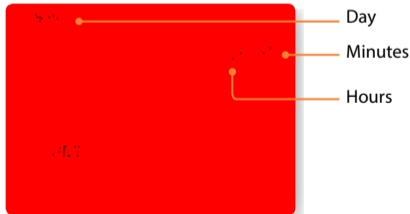



Locking the Time Clock

This time clock has a keypad lock facility. To activate the lock follow these steps.

- Press and hold the A and Down keys together for 10 seconds
- You will see the lock symbol appear on screen
- To unlock, repeat the steps above until the lock symbol disappears.



Note: The keypad lock indicator is only displayed when the lock is active.

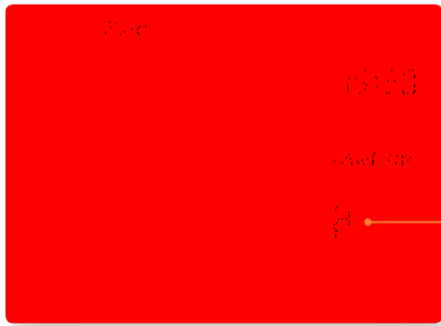







Keypad Lock Indicator



Setting the Switching Times

To program the switching times, follow these steps.

- Press the Clock button once 
- You will see Mon (7 day mode), Mon - Fri (5/2 day mode) or Mon -Sun (24H mode) displayed on screen. Use the Up/Down buttons to select the TIMER ON for the WAKE switching period 
- Press H to confirm settings..... 
- Use the Up/Down buttons to select the TIMER OFF for the WAKE switching period 
- Press H to confirm settings..... 
- Repeat these steps for LEAVE, RETURN and SLEEP levels.
- For unused periods set the time to -- : -- and the time clock will ignore the setting.
- If set to 5/2-day mode you'll now see Sat Sun displayed on screen. Repeat steps above for the weekend settings.
- Press A to confirm settings and return to main display..... 



Countdown Mode

• Use the Up/Down buttons to set the countdown duration



• Press A to confirm settings



• Hold For will appear showing the time left.

When Hold For is displayed on screen, the output will be active.



Hold For Icon

Hold Time Remaining

Timer Status

To cancel a countdown period, reduce time to 00:00.



Timer Override

The time clock is able to override its current timer status.

If current status = Timer ON, – pressing A will switch it to Timer OFF **A**

(TIMER OFF will flash to inform you the programmed output has been overridden)

The time clock will return to the program at the next programmed time.

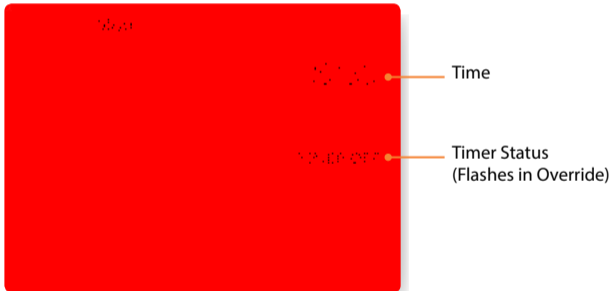





Holiday

The holiday function allows you to quickly enter a holiday setting.

During a holiday, the time clock will maintain TIMER OFF.

At the end of your holiday, the time clock will revert back to the programmed setting.

- Press H once (you will see the suitcase displayed on screen)..... 
- Use the Up/Down buttons to enter the number of days holiday 
- Press A to confirm settings..... 

The display will show a suitcase indicating the time clock is in holiday mode.

Note: A holiday period does not start until 00:00 the next day. For example, if you set a holiday period on Friday for 2 days, Saturday will be counted as the first day and the time clock will revert back to the programmed schedule at 00:00 on Monday.

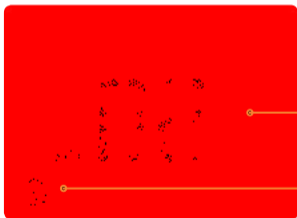

Holiday Days

ON Indicator

To cancel, follow the same steps but reduce the holiday duration to 00 days.



Optional Features Explained

THE FOLLOWING SETTINGS ARE OPTIONAL AND IN MOST CASES NEED NOT BE ADJUSTED

Feature 01 – Programming Mode: The following program modes are available; 5/2 Day Programming – 4 levels for the weekdays and 4 different levels for the weekend.

7 Day Programming – 4 levels for each day.

24 Hours – 4 levels over a 24-hour period.

Feature 02 - Time Clock Mode: Here you can set in which mode you would like the time clock to operate. The options are, Countdown Timer or Programmable (Switching Times).



Optional Features - Table

Time Clock

FEATURE	DESCRIPTION	SETTING
01	Programming Mode	00 = 5/2day (default), 01 = 7day, 02 = 24 hours
02	Time Clock Mode	00 = Countdown, 01 = Programmable (Default)



Adjusting the Optional Settings

To adjust the optional settings, follow these steps.

- Press and hold the Power button to turn the time clock OFF.....
- Press and hold the Clock key until the display appears as shown below.....

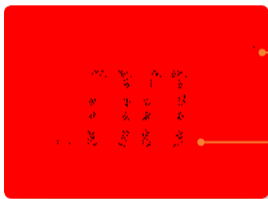

Feature Number

Setting Value

- Use the Clock key to cycle through the features
- Use the Up/Down keys to change the setting.....
- Press A to confirm settings
- Press the Power button once again to turn the time clock back ON





Wiring Diagram - Slimline to Boiler 230v

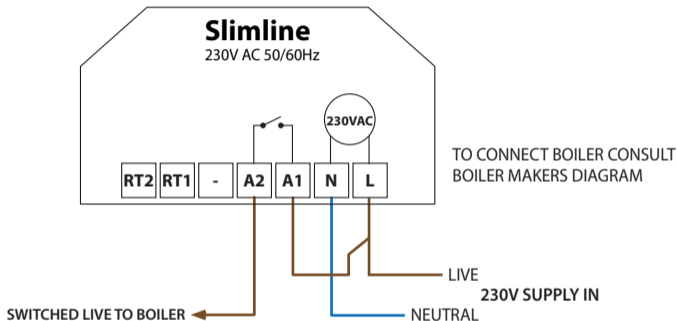

This product must only be installed by a qualified electrician and comply with local installation regulations!



Wiring Diagram - Slimline to Boiler Voltfree

THIS UNIT MUST BE PROTECTED BY A FUSE OR RCD

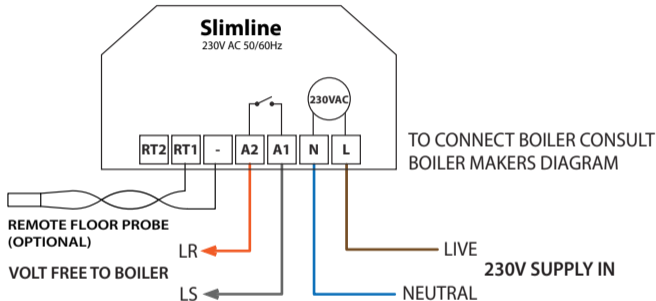

LS & LR ARE NORMALLY THE
ROOM THERMOSTAT CONNECTIONS



This product must only be installed by a qualified electrician
and comply with local installation regulations!



Wiring Diagram - Slimline to Spring Return Valve

THIS UNIT MUST BE PROTECTED BY A FUSE OR RCD

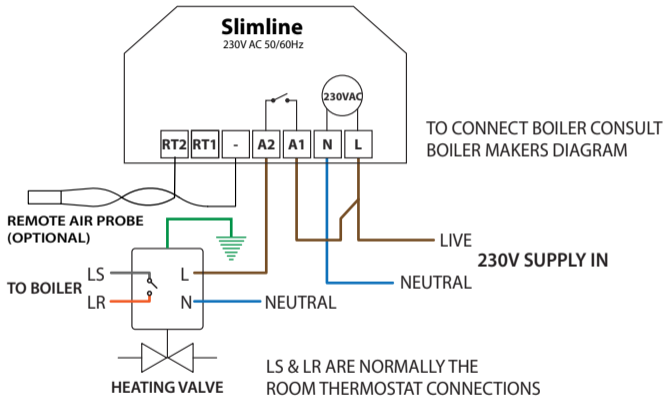

This product must only be installed by a qualified electrician and comply with local installation regulations!



Notes

The time clock can be used to control various devices in and around your home, e.g. lighting or towel rails.

Refer to the manufacturers instructions for wiring to these devices.

.....

.....

.....

.....

.....

.....

.....

.....

.....

.....

.....

.....

.....

.....

.....



Notes

A series of 18 horizontal dotted lines for taking notes.



Want More Information?

Call our support team on: +44 (0)1254 669090

Or view technical specifications directly on our website:
www.heatmiser.com



PDF



FAQ



VIDEO



Twitter: @heatmiseruk



Facebook: facebook.com/thermostats