



neoStat-HC1

Smart Fan Coil Thermostat



Proven quality...

heatmiser

...in a new look

IMI Heatmiser

Model:  Stat-HC1





Table of Contents

Product Image	1	Locking/Unlocking the neoStat-HC1	19
Table of Contents	2	Frost Protection	20
Installation Procedure	3-4	Holiday	21
System Type	5-6	Ventilation Mode	22
Pairing the neoHub	7	Feature Menu Settings Explained	23-24
Pairing the neoStat-HC1	7	Adjusting the Feature Menu Settings	25
What is a Mesh Network?	8	Feature Menu	26-27
Approach Sensor	8	Re-calibrating the Thermostat	28
LCD Display	9-10	Error Codes	28
Temperature Display	11	Diagrams	29-33
Power ON/OFF	12	Factory Reset	34
Setting the Time and Date	13	Statement of Compliance	34
Mode Select	14		
Fan Speed	14		
Setting the Comfort Levels	15-16		
Manual Temperature Control	17		
Temperature Hold	18		



Installation Procedure



Do

Mount the thermostat at eye level.

Read the instructions fully so you get the best from our product.



Don't

Do not install near to a direct heat source as this will affect functionality.

Do not push hard on the LCD screen as this may cause irreparable damage.

This thermostat is designed to be flush mounted and requires a back box of 35mm (minimum depth) to be sunk into the wall prior to installation.

Step 1

Using a small screwdriver, slightly loosen the screw from the bottom face of the thermostat. Then carefully separate the front half from the back plate.

Step 2

Place the thermostat front somewhere safe.

Terminate the thermostat as shown in the diagrams on pages 29-33 of this booklet.

Step 3

Screw the thermostat back plate securely into the back box.

Step 4

Clip the front of the thermostat onto the back plate, securing it in place with the retaining screw.

1



2



3



4





System Type

'System Type' makes sure that the thermostat operation and switched outputs are configured to the correct installation.

**Key: NO = Normally Open Switch, NC = Normally Closed Switch
GND and AO = 0-10 Volt Fan Output.**

01= 2 Pipe System Manual Select Heat or Cool

Heat, Cool & Ventilation modes both with 3 speed fan and Normally Open, Normally Closed valve connection method.

Heat = Auto & Manual fan.

Cool = Auto & Manual fan.

Vent = Manual 3 speed selectable fan.

Terminal Outputs

Fan: 'GND', 'AO'.

Valve: 'V1' = NO, 'V2' = NC.

02 = 2 Pipe System Cool Only

Cool and Vent options only, with 3 speed fan and Normally Open, Normally Closed connection method.

Cool = Auto & Manual fan.

Vent = Manual 3 speed selectable fan.

Terminal Outputs

Fan: 'GND', 'AO'.

Valve: 'V1' = NO, 'V2' = NC.

03 = 2 Pipe System Manual Select Heat or Cool (Twin Valve output)

Heat, Cool, Auto & Ventilation modes with 3 speed fan (Cool & Vent only) and twin valve outputs.

Cool = Auto & Manual fan for cooling only!

No fan output for heating.

Vent = Manual 3 speed selectable fan.

Terminal Outputs

Fan: 'GND', 'AO'.

Valve: 'V1' for 'Cooling'

Valve: 'V2' for 'Heating'



System Type cont...

04 = 4 Pipe System Heat, Cool and Auto

Heat, Cool, Auto & Ventilation modes with 3 speed fan (all modes) and twin valve outputs.

Heat, Cool, Auto = Auto & Manual fan.

Vent = Manual 3 speed selectable fan.

05 = 2 Pipe System Heat, Cool with 2 stage heating.

Heat, Cool & Ventilation modes with 3 speed fan (all modes) and 2 stage heating output.

1st stage Heat = No Fan

2nd stage Heat = Auto & Manual fan.

Cool = Auto & Manual fan.

Vent = Manual 3 speed selectable fan.

Terminal Outputs

Fan: 'GND', 'AO'.

Valve: 'V1' for 'Cooling'.

Valve: 'V2' for 'Heating'.

Terminal Outputs

Fan: 'GND', 'AO'.

Valve: 'V1' for 'Cooling' & 2nd stage heating.

Valve: 'V2' for 'Heating'.

To select the desired 'System Type'.

- Use the 'Left/Right' arrow keys to highlight  then press and hold the Tick button for 3 seconds to turn off the display.....
- Press Tick to enter 'Setup'.....
- Repeatedly press the 'Up' key until you see '10' displayed top right of the screen.....
The large 2 digit number now represents the 'System Type'.
- Use the 'Left/Right' arrow keys to select the desired type from the list above.....
- Press Tick to confirm selection.....

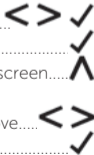











Pairing the neoHub

- Connect the neoHub to your router with the ethernet cable provided.
- Connect the neoHub power supply also provided with the hub.
- Download the neoApp and register your account. Sign in to your account, select the 'Add neoHub' option and follow the simple step by step pairing instructions.
- Once you've paired the hub to your account, the next step is to add the neoStat-HC1. The app will prompt you to "Add Zone." Follow the on-screen instructions to enter a name for the zone. When the pairing countdown begins, proceed with the steps outlined below:



Pairing the neoStat-HC1

- On the neoStat-HC1, use the Left / Right keys to select , then press and hold Tick   
 - SETUP will be highlighted, now press the Tick key once 
 - Press the Tick key once again to pair the neoStat to the neoHub 
- The  symbol appears flashing on the display. When the neoStat-HC1 successfully connects to the neoHub the  symbol will be permanently displayed.

- In the app, Press ADD ANOTHER for additional zones or press FINISH to complete setup.

Please note, you only have to pair the neoHub to your account once.
To pair any additional Neo's, select the + icon in the app, then 'Add Thermostat'.



What is a Mesh Network

NeoStats work using a mesh network, meaning neoStats have the ability to send & receive signals via other thermostats on the network. This signal is relayed from one thermostat to another until it reaches its destination. This communication method extends the communication range whilst offering increased network stability when compared with standard RF thermostats.

The Mesh symbol is shown when the device is communicating with the neoHub, if the mesh symbol disappears this indicates connection to the neoHub has been lost.



Approach Sensor

The neoStat-HC1 uses proximity to detect when you are about to use the touch keys. As you approach the neoStat-HC1, the touch keys and backlight will light up. This can be useful if you need to adjust the set temp or time, in a dark room.

LCD LCD Display

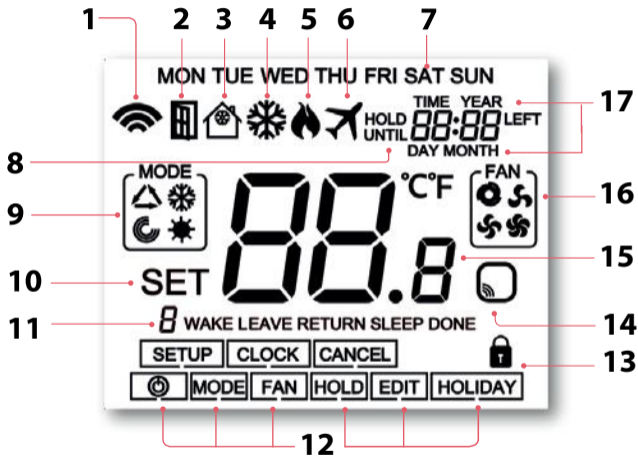

1. Mesh Symbol - Displayed when connected to the neoHub.
2. Window Icon - Displays when Window/Door Switch is triggered.
3. Frost Protection/Standby – Displayed when frost protection is enabled.
4. Cool Symbol – Displayed when cooling is active.
5. Flame Symbol – Displayed when the thermostat is calling for heat and flashes when optimum start is active.
6. Holiday – Displayed when the thermostat is in holiday mode.
7. Day Indicator - Displays the day of the week.
8. Until/Hold - Displayed when the neo-HC1 has been manually overridden to the next programmed comfort level, or held to a certain temperature for a select period.
9. Mode Indicator – Displays current mode of operation (Auto, Heat, Cool, Ventilation).
10. Set – Displays when changes are being made to the configuration and current set temperature points.
11. Program Indicator - Displayed during programming to show which period is being altered.
12. Main Menu – Highlighted text indicates selected option.
13. Keypad Lock Indicator – Displayed when the keypad is locked.
14. Sensor Warning - Flashes on screen when the thermostat has failed to receive a signal from a Wireless Sensor or Window Switch.
15. Temperature – Displays the ambient room temperature in Celsius or Fahrenheit.
16. Fan Icons – Static display icon when the fan is activated and flashes while selecting the desired fan speed.
17. Time/Day/Month/Year - Displays when setting the Clock/Calendar or a Holiday period.



Temperature Display

This thermostat will always show the ambient room temperature. If wireless remote sensors are paired, ('neohub' required) the display will automatically show an average temperature between both sensors.

Room Temperature



Set Temperature



To view the set temperature (Heat or Cool modes only):

- Press either the 'Up' or 'Down' arrow key..... ^v
- Press tick to return to main screen..... ✓

To view the set temperatures for (Auto Heat/Cooling):

- Use either the 'Up' or 'Down' arrow key once to view 'HEAT/COOL' set temp..... ^v
Note: The temperature that shows first is determined by the mode that is currently active.
 - Press tick to view the next set temperature..... ✓
 - Press tick a second time to return to main screen..... ✓
- The 'SET' screen will timeout after 5 seconds if the tick button is not pressed.



Power On/Off

The heating is indicated ON when the flame icon is displayed.

When the flame icon is absent, there is no requirement for heating to achieve the set temperature but the neoStat remains active.

- To turn the neoStat-HC1 off completely, scroll to the Power Icon and hold the Tick key for approximately 3 seconds until the display goes blank <>✓
The display and heating output will be turned OFF.
- To turn the thermostat back ON, press the Tick key once ✓

Thermostat completely OFF



Thermostat powered ON





Setting the Time and Date

To set the clock, follow these steps.

- Use the Left / Right keys to select ⏻.....
- Press and hold Tick to turn off the main display.....
- Use the right arrow key to select CLOCK.....
- Press Tick to confirm selection.....
- Use Up / Down keys to set the year.....
- Press Tick to confirm selection.....
- Repeat the steps to set the Month, Date & Time.....
- Press Tick to confirm the new clock settings.....
- Use the down arrow to select ⏻.....
- Press Tick to turn the display on.....



M

Mode Select

The neostat-HC1 can be used as a heating/cooling thermostat and a fan ventilation controller, (mode options dependent on 'System Type' pages 5 & 6).

To select the mode:

- Use the 'Left/Right' keys to scroll to 'MODE' then press Tick..... <> ✓
- Repeatedly press the Tick key to select the mode..... ✓



Auto



Cool



Heat



Vent



Fan Speed

The neoStat-HC1 allows for manual or automatic fan control for both heating and cooling. When set to manual there are 3 options, 'Low', 'Medium' & 'High'. In auto, the thermostat will choose the correct fan speed dependent on set temperature to actual temperature difference.

1°C/2°F = Low Fan

2°C/4°F = Medium Fan

3°C/6°F = High Fan

To select the fan speed:

- Use the 'Left/Right' keys to scroll to 'FAN' then press Tick..... <> ✓
- Repeatedly press the Tick key to select the speed..... ✓



Setting the Comfort Levels

The neoStat-HC1 offers three program mode options; Weekday/Weekend, 7 Day and 24Hour programming. There is also the option to use the neoStat-HC1 as a manual thermostat. The thermostat is supplied with comfort levels already factory programmed, but these can be changed easily.

The default times and temperature settings are;

Heating defaults

07:00 - 21°C (Wake) 09:00 - 16°C (Leave) 16:00 - 21°C (Return) 22:00 - 16°C (Sleep)

Cooling defaults

07:00 - 23°C (Wake) 09:00 - 26°C (Leave) 16:00 - 23°C (Return) 22:00 - 26°C (Sleep)

Time input for unused levels must be set to --:-- so that the neoStat-HC1 will skip these and continue on to the next programmed time.

Auto Mode

In 'Auto' mode you will set both 'HEAT' and 'COOL' set points for each level. To disable cooling for a particular level, adjust the 'COOL' set point by a continual press of the 'Up' key until the display shows --.-

Note: For Weekday/Weekend programming, the four comfort levels are the same for Mon-Fri, but can be different for Sat-Sun. For 7 Day programming each day of the week can have four different comfort levels. In 24 Hour mode all days are programmed the same.

- To program the comfort levels, use the Left / Right keys to scroll to EDIT..... <>
- Press Tick to confirm selection..... ✓
- Use the Left / Right keys to select day / period of the week (selection will flash). <>
- Press Tick to confirm selection..... ✓
WAKE will now flash and the current time and temperature setting will be shown.
- Press Tick to alter WAKE settings..... ✓
- Use the Up / Down keys to set the hours then tick to confirm..... ↑ ↓ ✓
- Use the Up / Down keys to set the minutes then tick to confirm..... ↑ ↓ ✓
- Use the Up / Down keys to set the temperature..... ↑ ↓ ✓
- Press Tick to confirm the settings..... ✓

Note: At this stage in 'Auto' you will be prompted to enter the 'COOL' temperature immediately following the 'HEAT' input.

- Press Tick to confirm the settings..... ✓
- Press the right arrow key..... >
- 'LEAVE' will now flash and the current settings will be displayed.

Tip: In 'Auto' mode you can quickly glance at both 'HEAT' & 'COOL' temperatures by pressing the 'Up/Down' keys while the selected level is flashing.

- Press Tick to alter 'LEAVE' settings..... ✓
 Repeat these steps to set all comfort levels. For any unused periods set time to --:--
- Use the Left / Right keys to scroll to DONE and press Tick..... <> ✓



Manual Temperature Control

The 'Up/Down' keys allow you to adjust the current set temperature. When you press either key, you will see the word 'SET' and the desired temperature value.

- Use the 'Up/Down' keys to adjust the 'SET' value..... ^v
- Press Tick to confirm settings and return to the main display..... ✓

In 'Auto' mode you are required to set both 'Heat' and 'Cool' temperatures!

Indicates whether Heat or Cool is being set.



Set Temperature

Set Icon

Note: This new temperature is maintained only until the next programmed comfort level.



Temperature Hold

The temperature hold function allows you to manually override the current operating program and set a different temperature for a desired period.

- Use the Left / Right keys to scroll to HOLD.....
- Press Tick to confirm selection.....
- Use the Up / Down keys to set the desired Hold period.....
- Press Tick to confirm selection.....
- Use the Up / Down keys to set the desired Hold temperature.....
- Press Tick to confirm selection.....



You will see the HOLD LEFT indication is displayed on screen.

The time will countdown the set duration and then revert to the normal program.

Note:

In 'Auto' mode both 'HEAT' and 'COOL' set points are required for the duration.



Hold Left Indicator

Hold Time Remaining

To cancel a temperature Hold:





- Use the Left / Right keys to scroll to HOLD.....
- Press Tick twice to confirm.....





Locking the neoStat-HC1

The neoStat-HC1 has a keypad lock facility. **To activate the lock follow these steps.**

- Use the 'Left/Right' keys to scroll to 'HOLD' & press Tick for 10 seconds..... 
- The display will show 0000. At this point enter a four digit pin number.
- Use the Up / Down keys to enter the first two digits..... 
- Press Tick to confirm..... 
- Use the Up / Down keys to enter the second two digits..... 
- Press Tick to confirm..... 



The display will return to the main screen and display the keypad lock indicator..... 

Note: The keypad lock indicator is only displayed when the lock is active.



Unlocking the neoStat-HC1

To unlock the neoStat-HC1 press Tick once. The display will show 00:00 and you will need to enter the four digit pin number you set previously.

- Use the Up / Down and Tick keys to enter the first two digits..... 
- Use the Up / Down and Tick keys to enter the second two digits..... 

The keypad will unlock and return to the main screen.



Frost Protection/Standby

- Use the Left / Right keys to scroll to the Power Icon.....<>⏻
- The frost icon will toggle ON/OFF each time Tick is pressed.....✓

In this mode, the 'neoStat-HC1' will display the frost icon and will only turn the heating ON should the room temperature drop below the set frost temperature. If the heating is turned ON whilst in frost mode, the flame symbol will be displayed.

To cancel the frost protect mode, navigate to the Power button again and press Tick.....✓

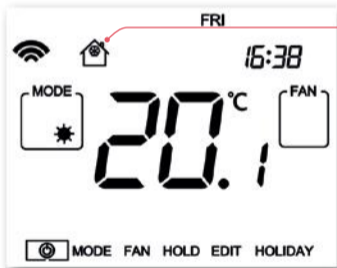

Frost Protection
Mode Enabled

In cooling and ventilation mode the thermostat will go to 'Standby'.



Holiday

The holiday function reduces the set temperature in your home to the frost protection temperature setting.

The thermostat will maintain this temperature for the duration of the holiday and will then automatically return to the program mode on your return.

Caution! If left in 'COOL' only mode the holiday function will place the thermostat into standby and therefore 'Frost Protection' will not be available.

Set a date & time for the holiday period to end, using the steps below;

- Use the Left / Right keys to scroll to HOLIDAY and press Tick.....
- Use the Up / Down keys to set the year.....
- Press Tick.....
- Use the Up / Down keys to set the month.....
- Press Tick.....
- Repeat the steps to set the Date & Time.....
- Pressing Tick to confirm selection.....

Note: The holiday period will start immediately, and will return to the normal program at the time & date you have configured.

Cancel Holiday;

- Use the Left / Right keys to scroll to HOLIDAY and press Tick.....
- CANCEL will be highlighted, Press Tick to cancel.....



Ventilation Mode

In ventilation mode there is no heat or cool output only fan control. With no timer setting this mode is completely manual and is available in all 'SystemTypes'.

To select 'VENT' mode:

- Use the 'Left/Right' keys to scroll to 'MODE' then press Tick..... <>✓
- Repeatedly press the Tick key to select ..... ✓

Fan Icons

Low Fan



High Fan



Medium Fan



Auto Fan



(not used in 'VENT' mode).

To start/stop or change fan speed.

- Use 'Left/Right' keys to highlight 'FAN'..... <>✓
- Repeatedly press the Tick key to select between low, medium, high or off..... ✓



Feature Menu Settings Explained

THESE FEATURES ALLOW YOU TO SET THE CORRECT PARAMETERS FOR INITIAL SETUP.

Feature 01 – Pairing To neoHub: This function is used to pair the thermostat to the Hub.

Feature 02 - Switching Differential: This function allows you to increase the switching differential of the thermostat. The default is 1°C which means that with a set temperature of 20°C, the thermostat will switch the heating on at 19°C and off at 20°C. With a 2°C differential, the heating will switch on at 18°C and off at 20°C.

Feature 03 - Frost Protect Temperature: This is the temperature maintained when the thermostat is in Frost Mode. The range is 05 - 17°C. The default is 12°C and is suitable for most applications.

Feature 04 – Output Delay: To prevent rapid switching, an output delay can be entered. This can be set from 00 - 15 minutes. The default is 00 which means there is no delay.

Feature 05 – Temperature Up/Down Limit: This function allows you to limit the use of the up and down temperature arrow keys. This limit is also applicable when the thermostat is locked and so allows you to give others limited control over the heating system.

Feature 06 – Optimum Start: Optimum start will delay the start up of the heating system to the latest possible moment to avoid unnecessary heating and ensure the building is warm at the programmed time. The thermostat uses the rate of change information to calculate how long the heating needs to raise the building temperature 1°C (with a rate of change of 20, the thermostat has calculated the heating needs 20 minutes to raise the building temperature 1°C) and starts the heating accordingly.

Feature 07 – Rate of Change: Number of minutes for 1°C temperature rise.

Feature 08 – Program Mode: The neoStat-HC1 offers the following program mode options;

Weekday/ Weekend - 4 comfort levels for Monday - Friday and 4 comfort levels for Saturday/Sunday.

7 Day Program - Each day of the week has 4 comfort levels that can be programmed independently.

24 Hour program - All days of the week are programmed with the same levels.

Non-programmable - Simple up/down temperature control, no timing.

Feature 09 – Temperature Format: This function allows you to select between °C and °F.

Feature 10 – System Type: Configures the thermostat settings and switched outputs to best suit the heat and cool sources installed.

Feature 11 – Deadband: Only selectable when 'Auto' (HEAT & COOL) mode is enabled. Deadband is the temperature difference between the 'HEAT' and 'COOL' set points. This is to prevent heating and cooling operating at the same time working against each other. Example, 'HEAT' set point at 20°C with a Deadband of 2°C, the minimum allowed 'COOL' set point would be 23°C. This means that if 'COOL' was set to 22°C it would push the 'HEAT' set point to 19°C.

Feature 12 - Constant Fan: Fan will automatically run between 'Low', 'Med' & 'High' while there is a demand for heat or cool. When demand has stopped, the fan will continually run but in 'Low' speed only. If 'Constant Fan' is disabled, the fan will go off completely when heat or cool demand has ended. **Note: this feature is disabled in heating mode when 'System Type' is set to 03 = '2 Pipe System Heat or Cool Only'.**

Feature 13 - Cool Air Proof: To avoid blowing cold air from the fan coil when the thermostat requires heating, the coil valve will open for a set duration before fan starts blowing. Set range in seconds: 0, 5, 10, 15, 30, 60, 90. Default value=0 (disabled).

Feature 14 - Valve Cycling: Will operate each valve for 5 minutes if the outputs have not been operated by the thermostat within a set period of time. This action is randomised to prevent a collective demand on the system.



Adjusting the Feature Menu Settings

- Use the Left / Right keys to scroll to .....
- Press and hold the Tick button for 3 seconds.....
- SETUP will be highlighted, now press the tick key once.....

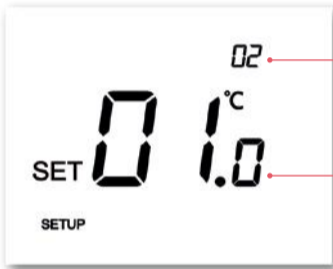

Feature Number

Setting Value

- Use the Up / Down keys to scroll through features.....
- Use the Left / Right keys to adjust the setting within each feature.....
- Press Tick to confirm and exit setup menu.....





Feature Menu

FEATURE	DESCRIPTION	SETTING
01	Pairing	Used to add zone to the neoHub
02	Switching Differential	00.5 = 0.5°C 01 = 1.0°C (Default) 02 = 2.0°C 03 = 3.0°C
03	Frost Protection Temperature	07° - 17°C (12°C = Default)
04	Output Delay	00 - 15 Minutes (00 = Default)
05	Up/Down Temperature Limit	00° - 10°C (00 = Default)
06	Optimum Start	00 - 05 Hours (00 = Default)
07	Rate of Change	Minutes to raise by 1°C
08	Program Mode	00 = Non - Programmable 01 = Weekday/Weekend (Default) 02 = 7 Day Programming 03 = 24 Hour Mode



Feature Menu









FEATURE	DESCRIPTION	SETTING
09	Temperature Format	00 = °C, 01 = °F (00 = Default)
10	System Type	01 = 2 Pipe System, Selectable Heat or Cool only. 02 = 2 Pipe System, Cool only. 03 = 2 Pipe System Heat & Cool (fans for Cool only). 04 = 4 Pipe System Heat, Cool & Auto. 05 = 2 Pipe System Cooling & 2 Stage Heating.
11	Deadband	2 to 10°C
12	Constant Fan	00 = Off (Default) 01 = On
13	Cool Air Proof	00 = Disabled (Default) 05, 10, 15, 30, 60, 90 seconds
14	Valve Cycling	00 = Default, no Action 11 = 5 mins after 1 week delay, once per week. 12 = 5 mins after 2 week's delay, once per week. 13 = 5 mins after 4 week's delay, once per week. 21 = 5 mins after 1 month's delay, once per month. 22 = 5 mins after 1 month's delay, twice per month. 23 = 5 mins after 1 month's delay, 4 times per month.



Re-calibrating the Thermostat

Attention! Re-calibrating this thermostat could cause it to operate incorrectly. Before you attempt to carry out this procedure please call the support line printed on the back page of this manual.

If you need to re-calibrate the thermostat, follow these steps.

- Use the Left / Right keys to scroll to the ..... 
- Press and hold Tick to turn the display OFF..... 
- Press and hold the Tick and Down keys together for 10 seconds..... 
- The current temperature will appear on the display.
- Use the Up / Down keys to configure the new temperature value 
- Press the Tick key to confirm the change and the display will go blank 
- Press the down arrow to highlight the ..... 
- Press the Tick key once to turn the thermostat ON..... 



Error Codes

The neoStat-HC1 will display an error code if there is a fault with the temperature sensor.

E0 = The internal sensor has developed a fault.



Wiring Diagram - Normally Closed Valve

System Types 01 & 02

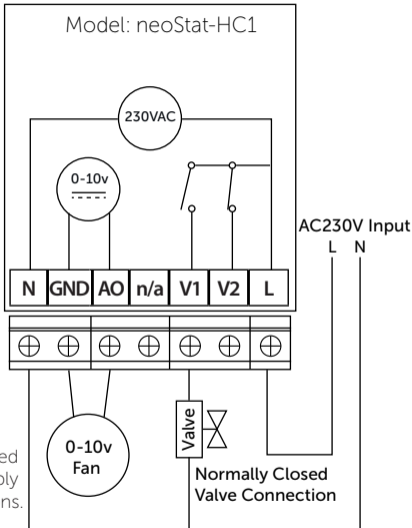

This product must only be installed by a qualified electrician and comply with local installation regulations.



Wiring Diagram - Normally Open Valve

System Types 01 & 02

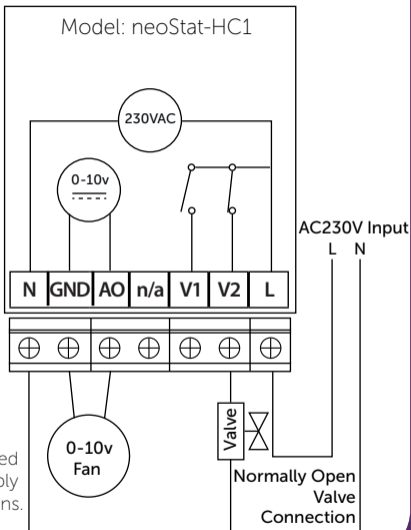

This product must only be installed by a qualified electrician and comply with local installation regulations.



Wiring Diagram - 3 Wire Valve Connection

System Types 01 & 02

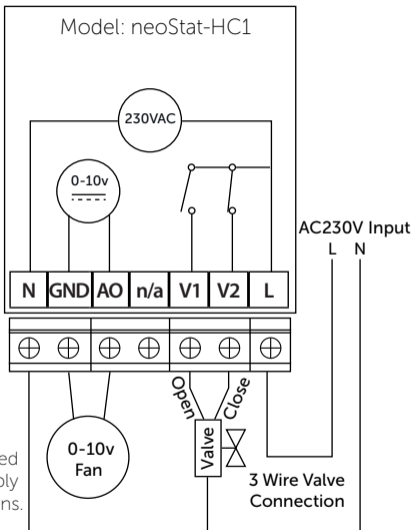

This product must only be installed by a qualified electrician and comply with local installation regulations.



Wiring Diagram - Fan Coil & Wet Systems

System Types 03 & 05

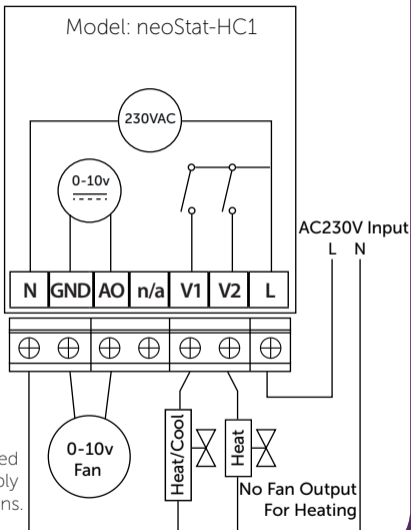

This product must only be installed by a qualified electrician and comply with local installation regulations.



Wiring Diagram - Heat & Cool Valves

System Type 04

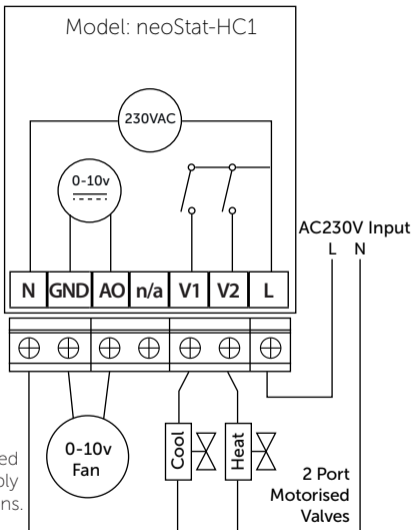



This product must only be installed by a qualified electrician and comply with local installation regulations.



Factory Reset

To reset the device to factory default settings, follow these steps:

- Use the Left / Right keys to scroll to  <> ⏻
- Press and hold Tick to turn the display OFF..... ✓
- SETUP will be highlighted..... <> ✓
- Press and hold the Tick key for 10 seconds..... ✓
- All of the icons on the display will appear for 2 seconds, followed by the 'Setup' entry screen
- Use the Down key to highlight  then press tick..... ✓✓
The neoStat-HC1 will revert to the main display.

Note: Factory reset will cancel all parameters that were entered during the set-up and pairing operations. These processes must be repeated after factory reset is completed.



Statement of Compliance,

neoStat family

Scan for the required Statement of Compliance, including the security update support period.





Want More Information?

Call our support team on: +44 (0)1254 669090

Or view technical specifications directly on our website:
www.heatmiser.com



PDF



FAQ

IMI Heatmiser
Units 1-5 Hurstwood Court, Mercer Way
Shadsworth Business Park, Blackburn,
Lancashire, BB1 2QU, United Kingdom.